

PEORIA, ARIZONA

---

## THE MICROTRON 24 - INSTALLATION INSTRUCTIONS

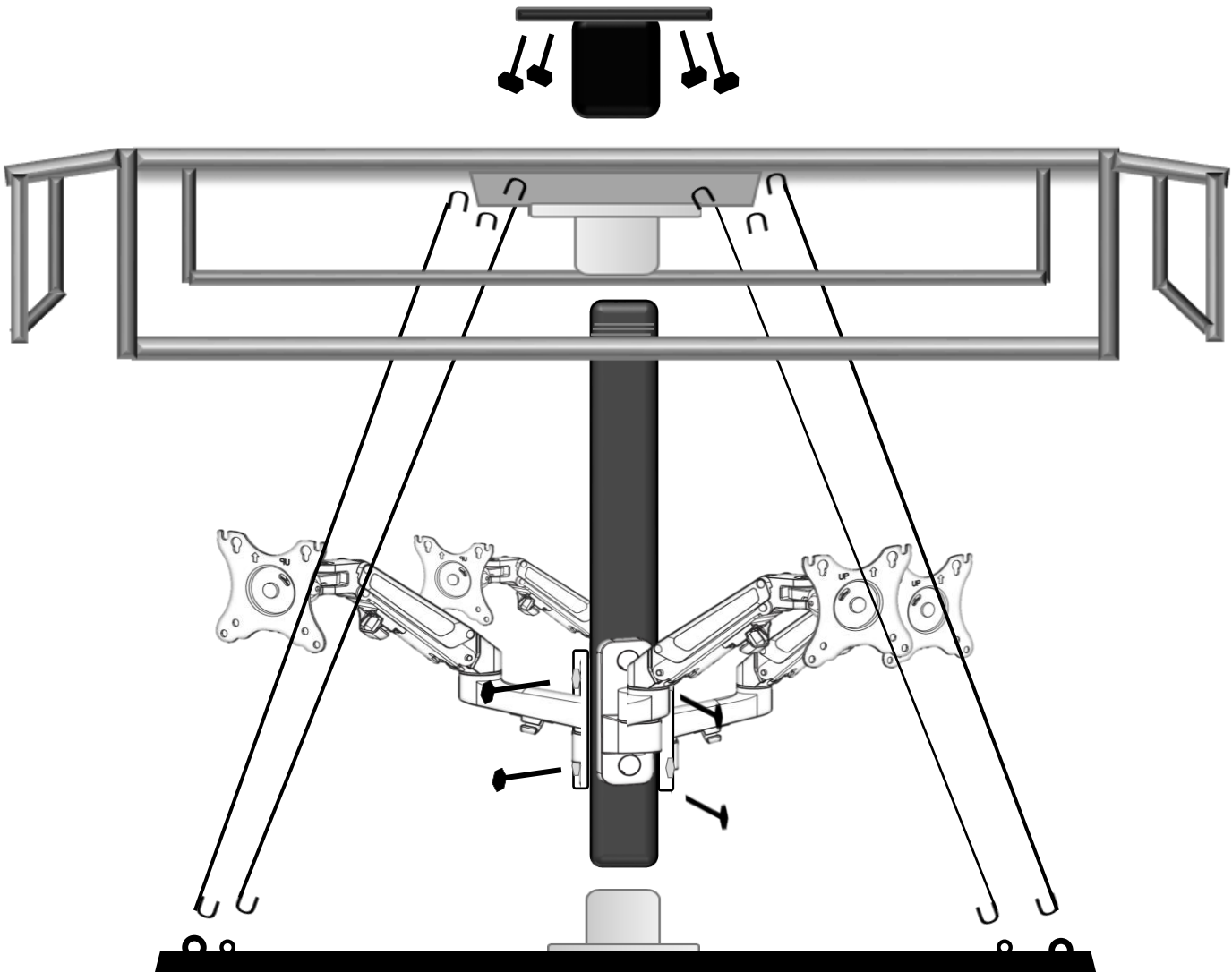

**PLEASE AFFIX GRAPHICS & VELCRO TO THE PLEXI-GLASS BEFORE BEGINNING THE INSTALLATION**

## **PLAY-BY-PLAY**

**PLEASE TAKE YOUR TIME WITH THESE INSTALLATION INSTRUCTIONS. PLEASE ASK SOMEONE TO HELP WITH ANY STEP HEAVY LIFTING.**

**WE TALKIN' ABOUT PRACTICE:** WE RECOMMEND PERFORMING A PRACTICE INSTALL ON A TABLE BEFORE ATTEMPTING TO MOUNT THE MINI JUMBOTRON TO THE CEILING. THIS PRACTICE INSTALL WILL RESULT IN A SMOOTHER CEILING INSTALL AS IT OFFERS AN OPPORTUNITY TO DIAL IN THE MOUNTS, ATTACH THE SEAL & VELCRO TO THE TVS, MOUNT LIGHTING, AND TIDY UP CORDS. IT IS MUCH EASIER TO MAKE THESE TWEAKS NOW BEFORE THE MINI JUMBOTRON IS RAISED.

**DURING ALL STEPS, PLEASE PROTECT THE MINI JUMBOTRON BASE SO IT DOES NOT SCRATCH.**

Before enjoying your Mini Jumbotron, you will need to assemble its guts. No guts, no glory.

Here is the play-by-play:

**STEP 1:** Find a sturdy table close to an electrical outlet for testing. Please protect the base of the Mini Jumbotron and place it on the table and insert the non-threaded end of the quad mount pole into the silver flange of the base. Tighten the 2 flange screws using a 3/16<sup>th</sup> Allen Key so that the pole does not spin. As you tighten the 2 flange screws to the pole please be sure the pole remains straight and plumb.

*Note: Tightening the flange screws unevenly, or too tightly, may make the pole sit crooked.*



**STEP 2:** Assemble the Quad TV Mounting System using the appropriate hardware.

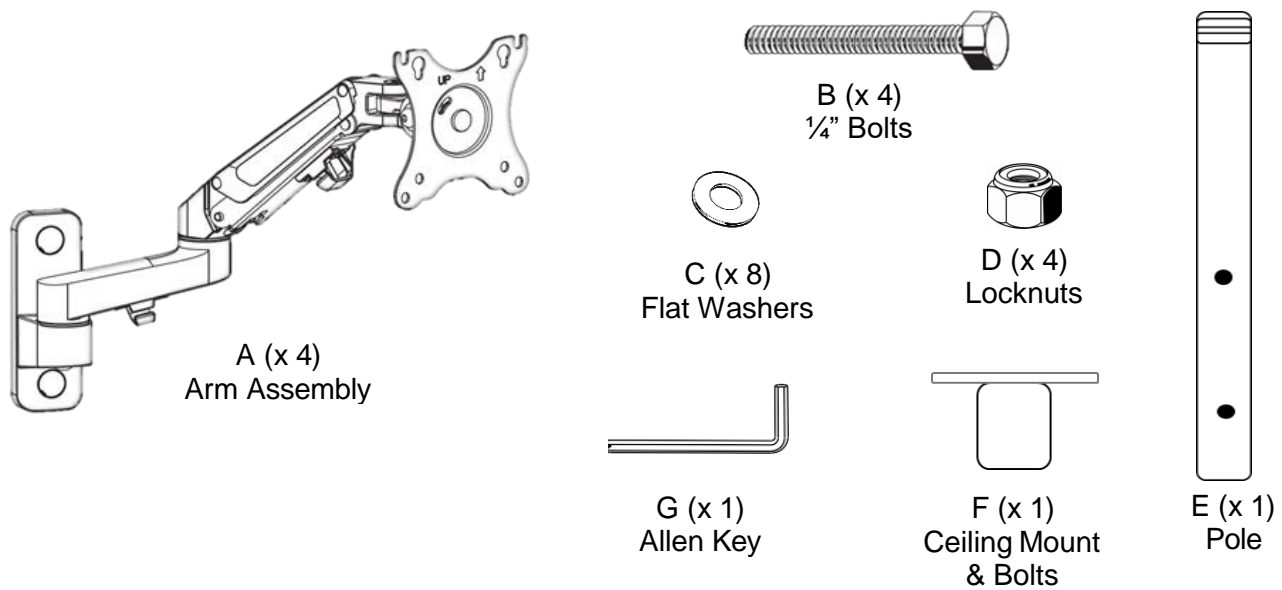

**NOTE:** Various sized TV screws & other hardware may be included. Some hardware may not be used.

**STEP 3:** Attach 2 Arm Assemblies (A) to the Pole (E) Using 2 Bolts (B), 4 Washers (C) and 2 Locknuts (D). Tighten securely with two 7/16" socket wrenches. Repeat this step to attach the remaining 2 arm assemblies to the pole.

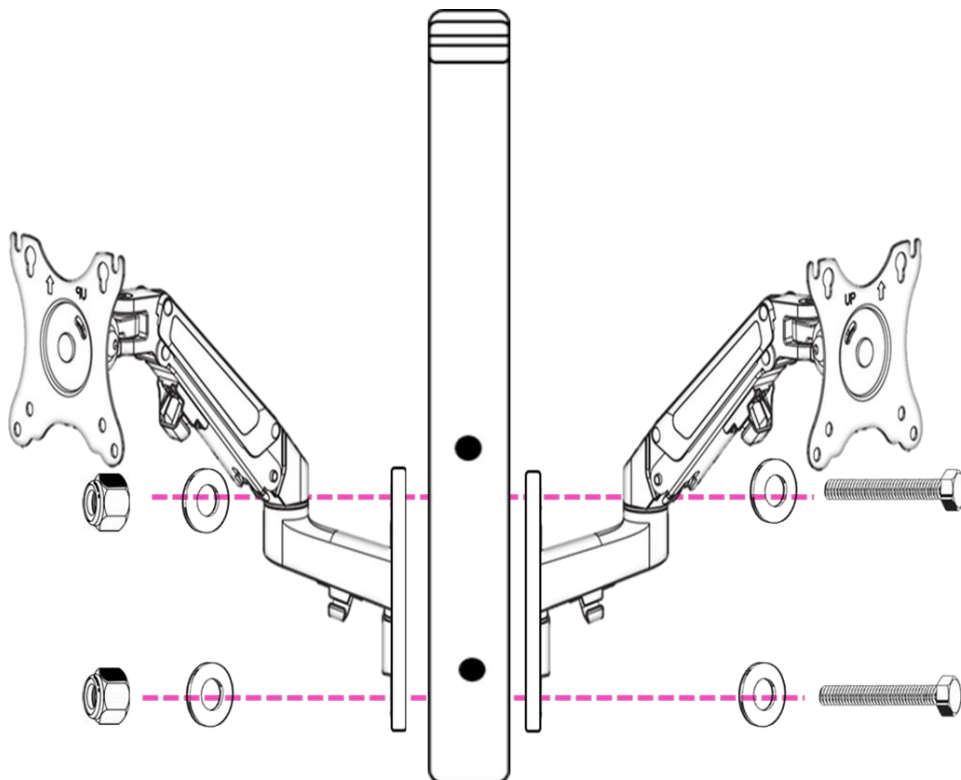

**STEP 4:** Mount the TVs. Locate the correct set of screws for your TVs. You may find it easier to hang the TVs if you first attach the top two screws into the back of the TV and then set your TV onto the mounting plate.

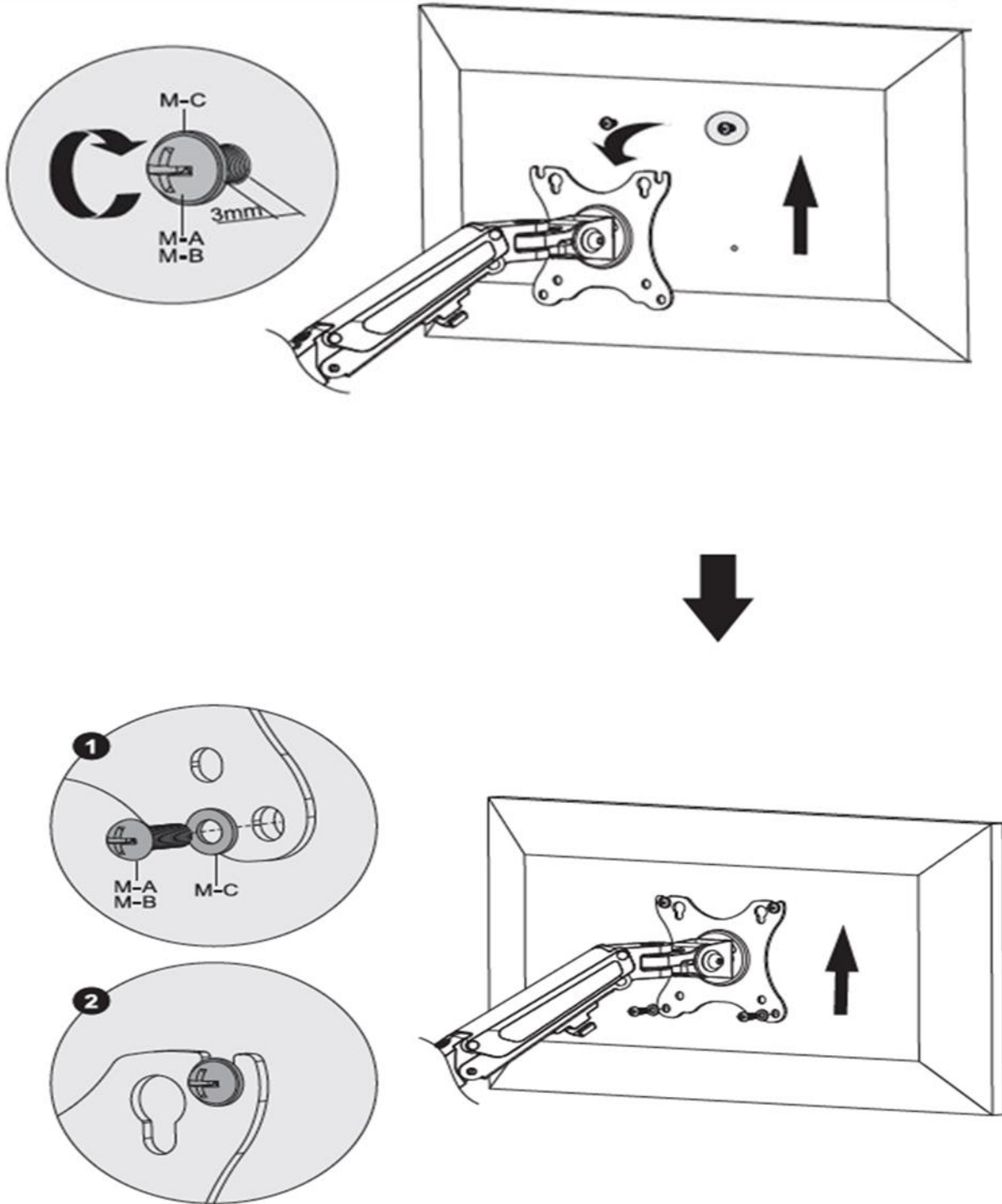

**STEP 5:** Adjust the gas spring tension to your personal preference using the Allen Key (G). You should be able to physically lower the TVs and position them onto of the foam on the base.

As needed: Insert the Allen Key (G) into the adjusting hole and turn clockwise (-) to reduce gas spring tension, suitable for lighter screens. Insert the Allen Key (G) into the adjusting hole and turn counter-clockwise (+) to increase gas spring tension, suitable for heavier screens. Please take note it may take numerous turns for gas spring tension adjustment.

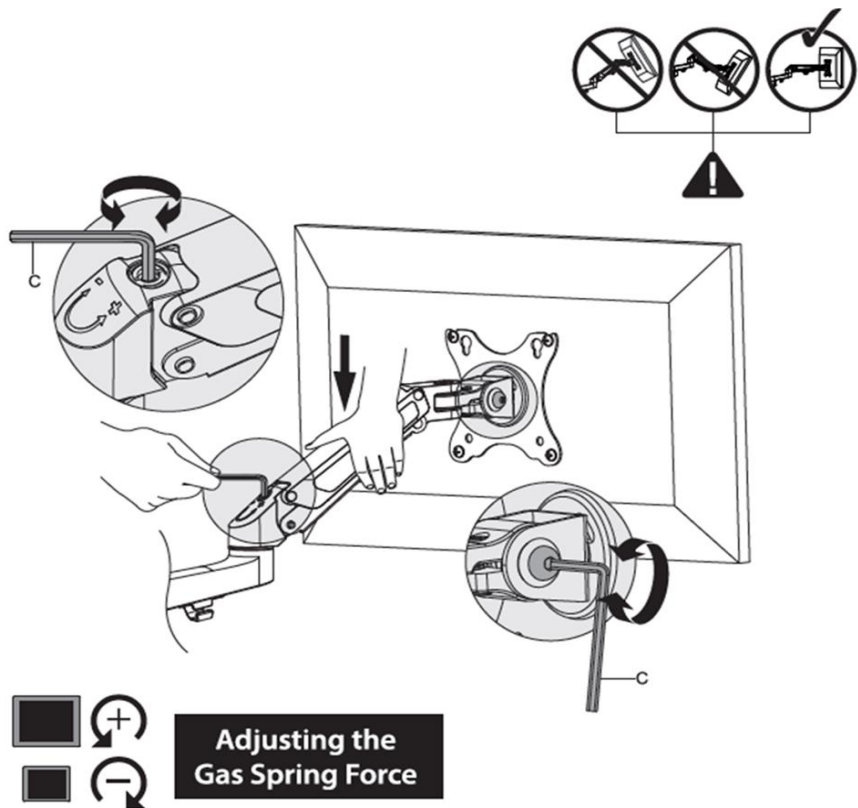

**Helpful Tips:**

- Each TV should be centered on their side of the base and should rest on the foam strip with the TV remote sensor visible.
- The bottom corners of your TVs should be set back just enough so that the Velcro on the bottom of your corner plexi-glass pieces will connect with the Velcro that is in each corner of the base.
- The top of each TV should be angled 10-15 degrees towards the floor. You will know if your TVs are positioned correctly once you add Mini Jumbotron frame. The rubber/foal seal on the bottom of the frame should rest level on top of your 4 TVs.

**STEP 6:** **Grab someone to help you with this next step.** Lift up the Mini Jumbotron metal frame and place the center silver flange of Mini Jumbotron frame over the top of the pole. Before lowering the frame, please make sure the TVs are angled correctly so that the rubber/foam seal on the bottom of the Mini Jumbotron frame will rest flat on top of all 4 TVs. Be careful not to scratch the TVs by making sure the TVs are in the appropriate angled position before lowering the frame.

**STEP 7:** Once your frame is resting level on top of your TVs, and no gaps exist between the frame and the TVs, you may tighten the flange screws of the Mini Jumbotron frame. As you tighten the flange screws please be sure the frame remains level and that there are no gaps between the top of the TVs and the frame.

*Note: Sometimes tightening the flange screws in the wrong order, unevenly, or too tightly makes the frame sit crooked creating gaps above the TVs. The TVs will hold up the frame so you don't need to tighten the flange screws too tightly.*

**STEP 8: PLEASE TAKE YOUR TIME WITH THIS NEXT STEP.** The 4 plexi-glass corner pieces will be held in place by both the Velcro on the metal Mini Jumbotron frame as well as the provided seal and Velcro that you will add to both sides of each TV. The seal and Velcro will also help eliminate any gaps between the TVs and the plexi-glass. Before starting this step you may want to test fit the plexi-glass so you have a good idea of where to put the seal and Velcro. See picture for ideal placement of both.

- ❖ You may notice that one side of the seal is more angled than the other. You'll want to apply the seal so that it forms a 45 degree angle.
- ❖ When applying the seal, keep the seal relatively flat with the front of the TV so that it doesn't stick out in front of the TV". Try not to allow the seal adhesive to show either. Take your time. If you mess up and need to order more seal you can do so [here](#).
- ❖ Apply pressure to the seal on the side of the TVs and give the adhesive 15 minutes to adhere before applying the Velcro. Then apply the Velcro and give the Velcro time to adhere as well.



**STEP 9:** Attach the corner plexi-glass pieces and adjust the TVs as necessary to get everything looking good. When you feel all four corners are in the right place you may tighten the TV mount angles.

**STEP 10:** Add the Ceiling Accent LED strip lighting to the very top of the metal Mini Jumbotron frame.

- ❖ Use alcohol wipes to clean the top of the frame before affixing any LED strip.
- ❖ Keep the strip about 1.25" away from the front edges of the metal frame. This will help hide the strip from being seen when your Mini Jumbotron is ceiling mounted. Ceiling accent lights look best when the strip is not visible.

**STEP 11:** You may also want to consider mounting the provided internal LED lights to the metal bracket that sits between the metal Mini Jumbotron frame and the silver flange that attaches to the pole. Take care not to interfere with where the bungee cords are hooked on top of this metal bracket and where the bungee cords connect to each corner of the base.

**STEP 12:** Let's go ahead and plug everything in and see how it all works. Try to keep the cords as short and tidy as possible. This is a good opportunity to download any related lighting apps and configure your lights. Please refer to the lighting manuals for instructions on which apps to download and how to set up your LED lights. **Information on the recessed lighting is on the final page of these instructions.**

## ALRIGHT ROOKIE – PRACTICE IS OVER. IT'S TIME TO MOUNT THIS BABY!

1. Securely fasten the ceiling mount to the ceiling. Make sure it installed in a location and in a manner that will support the total weight of your Mini Jumbotron. If you feel a dual joist bracket or extension pole is needed you will find links to these items in our [FAQs](#).
2. Remove any plexi-glass pieces you may have attached during the practice run and unplug all lighting.
3. Either remove the Mini Jumbotron frame completely or lift it high enough so that you may remove any TVs mounted during the practice run.
4. You have 2 installation options to consider for this next step:
  - **Option 1:** Remove the metal frame and all TV mounts from the pole. Loosen the flange screws on the base to free the pole. Lift the pole and securely screw the pole into your ceiling mount. Lift the metal Mini Jumbotron frame and push it up the pole as high as you can. Then tighten the flange screws. (You will lower the frame later onto the TVs but for now let's push it up out of the way). Reattach the TV mounts.
  - **Option 2:** Loosen the flange screws on the base to free the pole. Lift the pole, frame and mounts all together as one solid unit and securely screw the pole into your ceiling mount.
5. Re-attach the base. It may be helpful to use the bungee cords here. Tighten the flange screws and make sure the base remains level.
6. Re-install the 4 TVs, make sure they rest on the seal of the base and are angled properly.
7. Plug in everything.
8. Now lower the metal Mini Jumbotron frame so it rests on the 4 TVs and tighten the flange screws. The TVs should be sandwiched between the base and the frame. (If the bungee cords are causing the base to bend or bow too then you may remove the bungee cords. The bungee cords were added to the installation steps back when the base was comprised of different, much heavier material).
9. Attach the Velcro plexi-glass panels.
10. When you've got it looking good and something displaying on the TVs please text a brief video and pics to 623.606.6176. Congratulations and thank you!

### ENJOY YOUR MINI JUMBOTRON!

PS: If you have any tips on how I can improve the product or installation please let me know. Thank you!



PEORIA, ARIZONA

# RECESSED LIGHTING

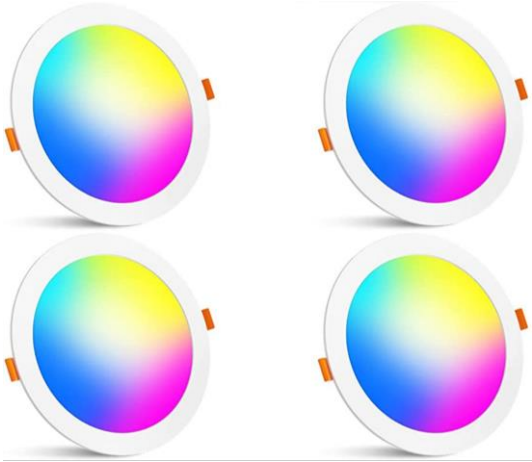

4 Inch Smart LED Recessed Ceiling Light Downlight 12W 1000 LM Daylight 5000K & RGB Dimmable by APP, 16 Million Colors - DIY Scenes - Timer - 23 Color Changing Modes



## BLUETOOTH APP CONTROL

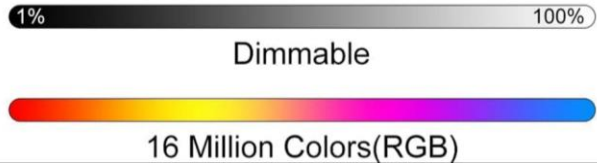

1. Download the “BRmesh” APP to your mobile device



Android 6.0 or newer



IOS 12.0 or newer

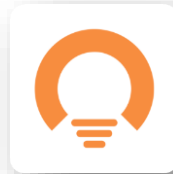

2. Open Bluetooth and the BRmesh APP, then follow the instructions to add the recessed lights to BRmesh. *No Wi-Fi or registration necessary.*

### Tips:

- To add the lights the phone must be within 25 feet of the lights. Walls, metals, etc. will severely shorten the distance of signal transmission.
- If the lights are not functioning properly, follow these steps:
  - Exit the APP
  - Turn off the Bluetooth on the phone
  - After 1 minute, turn on Bluetooth
  - Start the APP

If you have any questions, please contact us.

[www.Minijumbotron.com](http://www.Minijumbotron.com)